

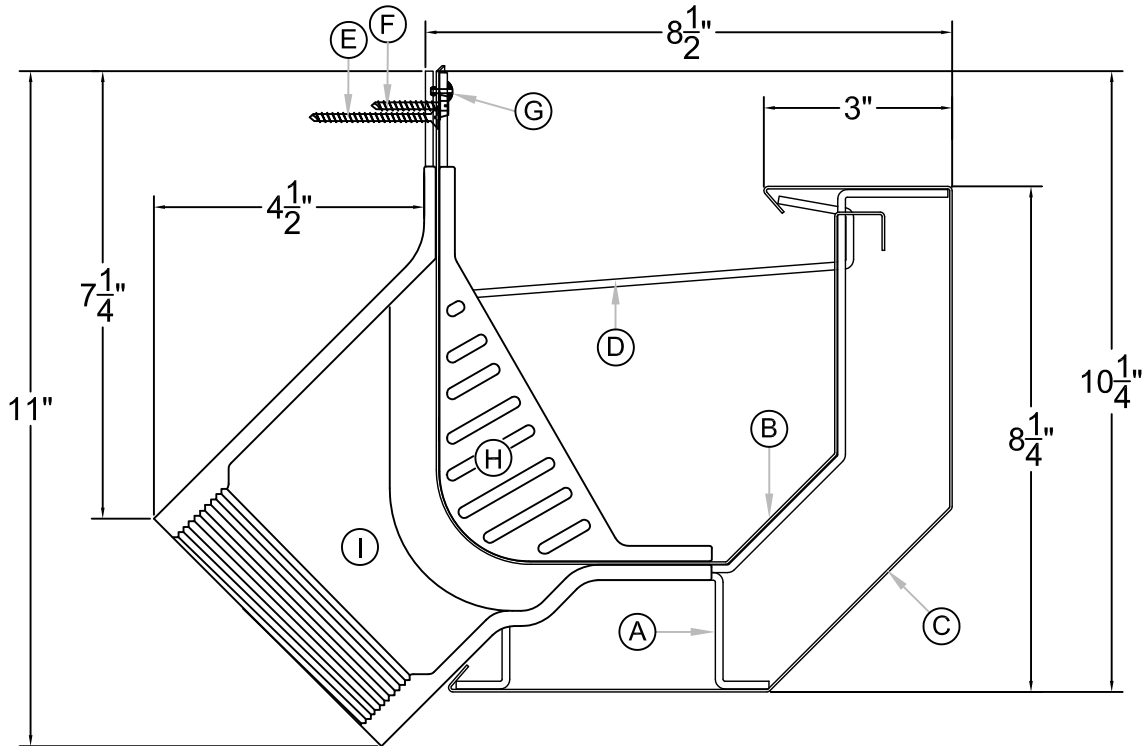

SUBMITTAL / DATA SHEET

Designer Series Gutter System
8" Contemporary Profile Type 1 Concealed Drain Model DSCT-8D1



Legend:

- A: Heavy Duty Support Brackets @ 30" Centers.
- B: Liner 10' Length, 1" Telescoping Lap Joint.
- C: Gutter Fascia 10' Length with 3/8" Expansion Reveal Joint
- D: Heavy Duty Interior Straps @ 30" centers.
- E: #10 x 2" S.S. Wood Screws
- F: 1-1/2" Stainless Nails or #10 x 1 1/2" S.S. Wood Screws
- G: Aluminum Rivet to Secure Interior Strap to Gutter.
- H: Cast Drain Leaf Grate, Attached to Drain with 4 Machine Screws
- I: Cast Drain, Available with 2", 3" & 4" Threaded Outlet. Drains are Mounted to a Specially Formed 36" Section of Liner called a Drain Receiver. This Receiver is Factory Punched for the drain's Opening and Fasteners. Field Assembly is Required

Material Options

Finish Options

Metal	Liner	Fascia
Aluminum		
0.040	<input type="checkbox"/>	<input type="checkbox"/>
0.050	<input type="checkbox"/>	<input type="checkbox"/>
0.063	<input type="checkbox"/>	<input type="checkbox"/>
0.080	<input type="checkbox"/>	
0.090	<input type="checkbox"/>	
0.125		
0.1875		
0.250		
Copper		
16 oz	<input type="checkbox"/>	<input type="checkbox"/>
20 oz	<input type="checkbox"/>	<input type="checkbox"/>
32 oz	<input type="checkbox"/>	<input type="checkbox"/>

Finish	Liner*	Fascia
EZ Mix Kynar	<input type="checkbox"/>	<input type="checkbox"/>
Custom Kynar	<input type="checkbox"/>	<input type="checkbox"/>
Anodized	<input type="checkbox"/>	<input type="checkbox"/>
Mill Finish	<input type="checkbox"/>	<input type="checkbox"/>

**Only interior of liner is finished*

Similar to the Designer Systems as Tested to Meet ANSI/SPRI GD-1 Standard Requirements

(Components Modified to accommodate internal drain)

Designer Series Commercial Gutter System, Contemporary Profile, Concealed Drainage:
 Not available with 6" profiles. This commercial gutter system is based on a concealed gutter design with a snap on decorative fascia. The gutter (liner) is manufactured pre-notched and punched to receive fasteners, heavy duty brackets and straps. The liner is tapered for a telescoping 1" lap joint to be sealed and riveted. The decorative fascia sections are snapped onto the liner's support bracket and locked into position via the internal liner strap. System components slightly modified from the standard 8" system as tested to ANSI/SPRI GD-1 Standards to accommodate internal drain. Designer Gutter Hardware Package Includes joint sealants, stainless screws and aluminum rivets (unpainted).

(Other Materials are Available upon Request)

*(Default Selection are **BOLD**)*

Customer:	Project:
Address:	Location:
Phone / Fax:	Architect:



Designer Series Gutter System 8" Contemporary Profile Type 1 Concealed Drain Model DSCT-8D1 (Parts List)

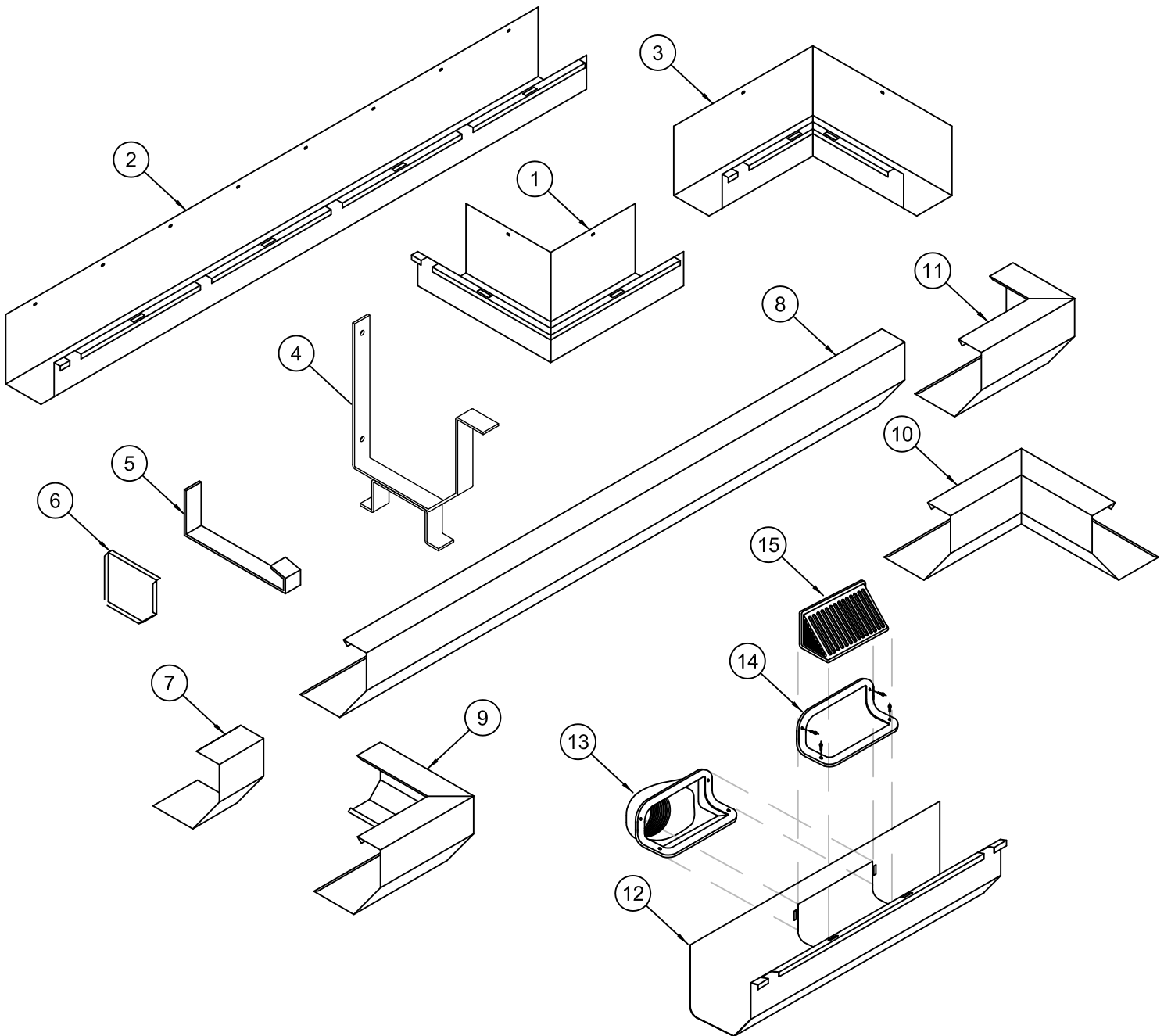

Legend:

- | | |
|-----------------------------------|--|
| 1. Gutter Liner Outside Miter | 9. Gutter Fascia Outside Miter |
| 2. Gutter Liner | 10. Gutter Fascia Inside Miter |
| 3. Gutter Liner Inside Miter | 11. Gutter Fascia End Cap (Lefthand Shown) |
| 4. Heavy Duty Support Bracket | 12. Aluminum Drain Receiver |
| 5. Heavy Duty Interior Strap | 13. Cast Drain |
| 6. Liner End Cap (Lefthand Shown) | 14. Flashing Clamp |
| 7. Fascia Splice Plate | 15. Removable Leaf Grate |
| 8. Gutter Snap on Fascia | |