

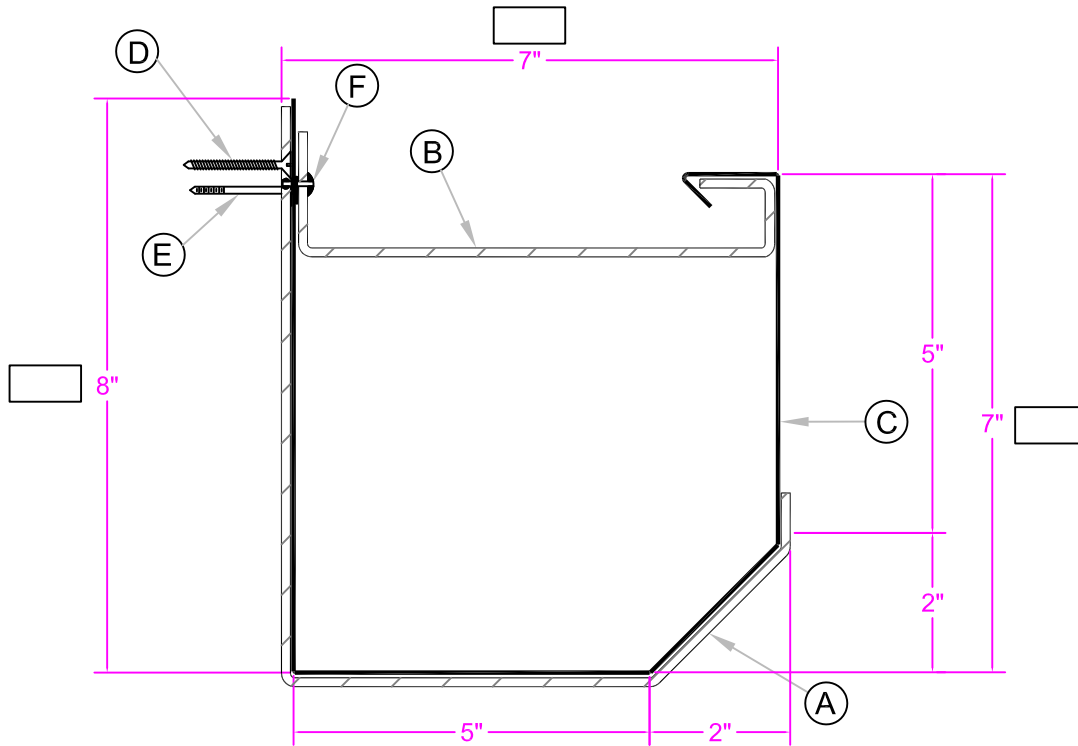

SUBMITTAL / DATA SHEET

**Industrial Series Commercial Gutter System
 G2-R8**



Legend:

- A: Heavy Duty Support Brackets @ 30" Centers. (Optional)
- B: Heavy Duty Interior Straps @ 30" centers.
- C: Gutter Profile 10' length, 1" telescoping joints.
- D: #10 x 2" S.S. Wood Screws
- E: 1-1/2" Stainless Nails or #10 x 1 1/2" S.S. Wood Screws
- F: Aluminum Rivet to Secure Interior Strap to Gutter.

Material Options

Finish Options

Component Options

Metal	Gutter	Bracket
Aluminum		
0.040	<input type="checkbox"/>	
0.050	<input type="checkbox"/>	
0.063	<input type="checkbox"/>	
0.080	<input type="checkbox"/>	<input type="checkbox"/>
0.090	<input type="checkbox"/>	<input type="checkbox"/>
0.125		<input type="checkbox"/>
0.1875		<input type="checkbox"/>
0.250		<input type="checkbox"/>
Copper		
16 oz	<input type="checkbox"/>	
20 oz	<input type="checkbox"/>	
32 oz	<input type="checkbox"/>	<input type="checkbox"/>

Finish	Gutter	Bracket
EZ Mix Kynar	<input type="checkbox"/>	<input type="checkbox"/>
Custom Kynar	<input type="checkbox"/>	<input type="checkbox"/>
Anodized	<input type="checkbox"/>	<input type="checkbox"/>
Mill Finish	<input type="checkbox"/>	<input type="checkbox"/>

Feature	Yes	No
Support Bracket	<input type="checkbox"/>	<input type="checkbox"/>
Rear Upper Flange	<input type="checkbox"/>	<input type="checkbox"/>
Custom Size	<input type="checkbox"/>	<input type="checkbox"/>

Industrial Series Commercial Gutter System: Available in 6", 8", 9" and 12" sizes with custom sizes available. These commercial gutter systems are based on a heavy duty support bracket and interior strap assembly. The gutter sections are manufactured in 10' lengths pre-notched and punched to receive fasteners. Gutter sections are tapered for a telescoping 1" lap joint that is field drilled, sealed and riveted. Gutter Hardware Package includes joint sealants, stainless screws, and aluminum rivets (unpainted).

(Other Materials are Available upon Request)

*(Default Selection are **BOLD**)*

Customer:

Project:

Address:

Location:

Phone / Fax:

Architect: