

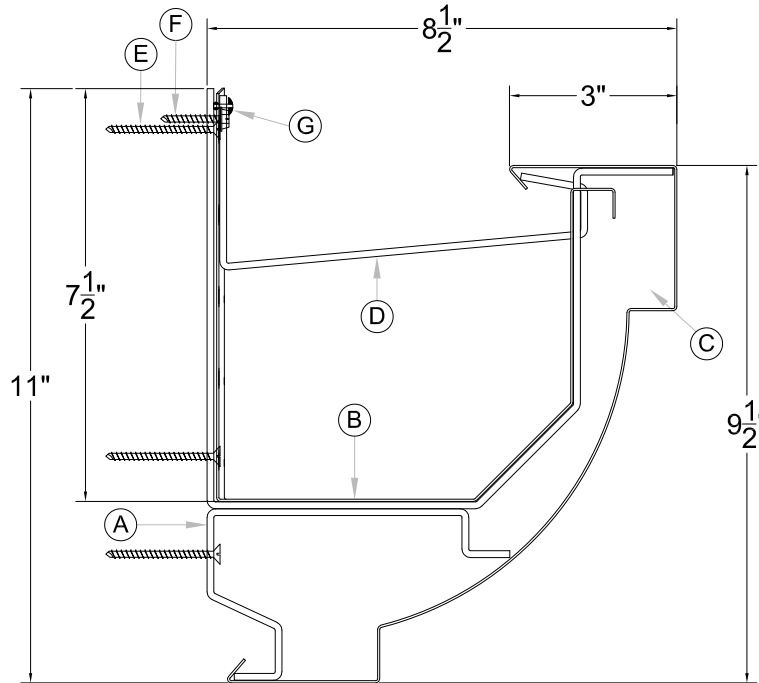

**Designer Series Gutter System**  
*Eclectic Collection*  
**8" Model DSEC3-8**



**Legend:**

- A: Heavy Duty Support Brackets @ 30" Centers.
- B: Liner 10' Length, 1" Telescoping Lap Joint.
- C: Gutter Fascia 10' Length with 3/8" Expansion Reveal Joint
- D: Heavy Duty Interior Straps @ 30" centers.
- E: #10 x 2" S.S. Wood Screws
- F: 1-1/2" Stainless Nails or #10 x 1 1/2" S.S. Wood Screws
- G: Aluminum Rivet to Secure Interior Strap to Gutter.

**Material Options**

**Finish Options**

Metal	Liner	Fascia
Aluminum		
0.040	<input type="checkbox"/>	<input type="checkbox"/>
0.050	<input type="checkbox"/>	<input type="checkbox"/>
0.063	<input type="checkbox"/>	<input type="checkbox"/>
0.080	<input type="checkbox"/>	
0.090	<input type="checkbox"/>	
0.125		
0.1875		
0.250		
Copper		
16 oz	<input type="checkbox"/>	<input type="checkbox"/>
20 oz	<input type="checkbox"/>	<input type="checkbox"/>
32 oz	<input type="checkbox"/>	<input type="checkbox"/>

Finish	Liner*	Fascia
EZ Mix Kynar	<input type="checkbox"/>	<input type="checkbox"/>
Custom Kynar	<input type="checkbox"/>	<input type="checkbox"/>
Anodized	<input type="checkbox"/>	<input type="checkbox"/>
Mill Finish	<input type="checkbox"/>	<input type="checkbox"/>

*\*Only interior of liner is finished*

**Similar to the Designer Systems as Tested to Meet ANSI/SPRI GD-1 Standard Requirements**

*(System design is equal to tested systems)*

**Designer Series Commercial Gutter System, 8" Model DSEC3-8:** This commercial gutter system is based on a concealed gutter design with a snap on decorative fascia. The gutter (liner) is manufactured pre-notched and punched to receive fasteners, heavy duty brackets and straps. The liner is tapered for a telescoping 1" lap joint to be sealed and riveted. The decorative fascia sections are snapped onto the liner's support bracket and locked into position via the internal liner strap. System design is equal the Colonial & Roman systems as tested to ANSI/SPRI GD-1 Standards. Designer Gutter Hardware Package Includes joint sealants, stainless screws, and aluminum rivets (unpainted).

*(Other Materials are Available upon Request)*

*(Default Selection are **BOLD**)*

Customer:

Project:

Address:

Location:

Phone / Fax:

Architect:



## Designer Series Gutter System

### *Eclectic Collection*

### 8" Model DSEC3-8

### (Parts List)

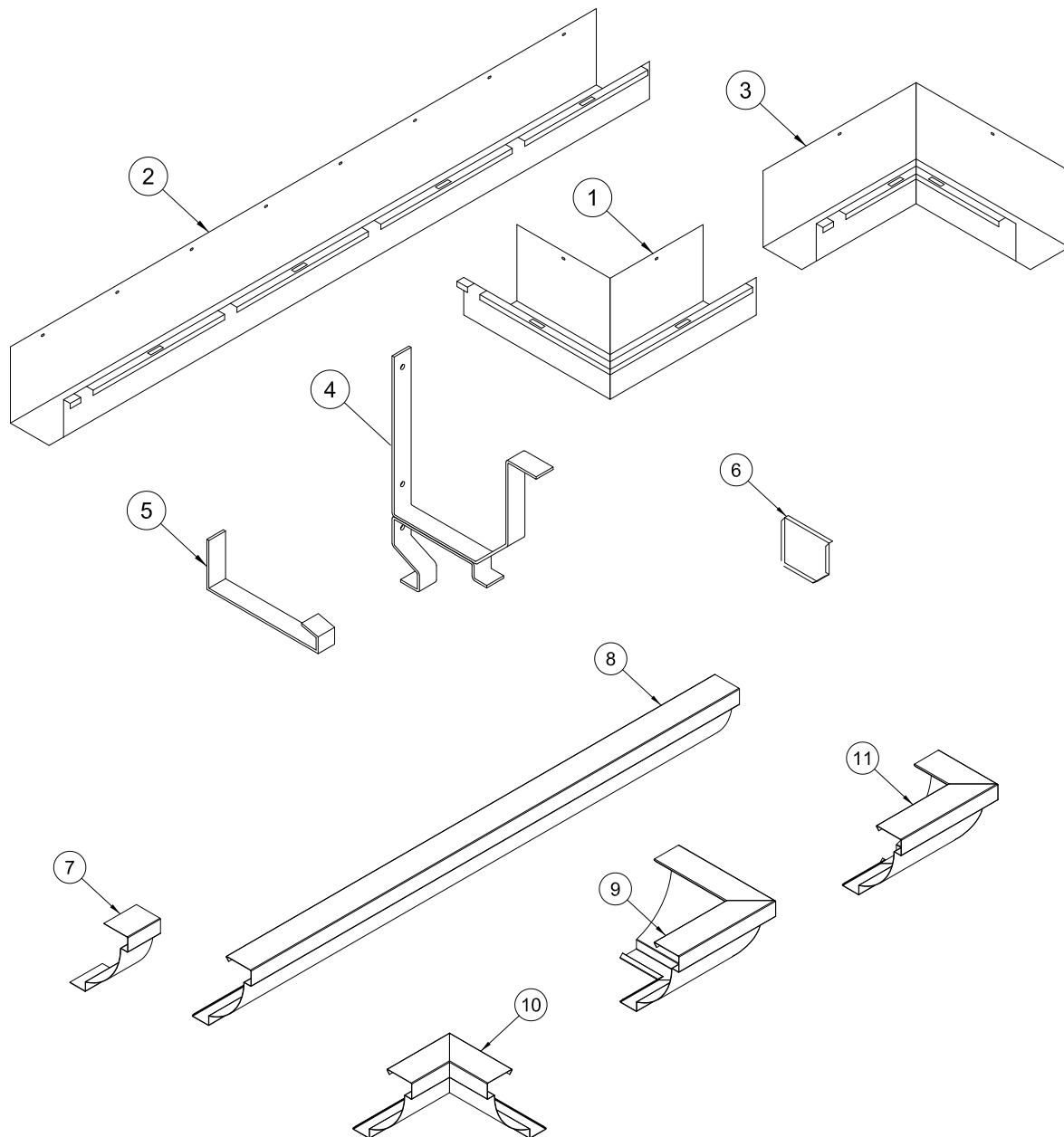

**Legend:**

- |                                   |  |
|-----------------------------------|--|
| 1. Gutter Liner Outside Miter     | 7. Fascia Splice Plate                     |
| 2. Gutter Liner                   | 8. Gutter Snap on Fascia                   |
| 3. Gutter Liner Inside Miter      | 9. Gutter Fascia Outside Miter             |
| 4. Heavy Duty Support Bracket     | 10. Gutter Fascia Inside Miter             |
| 5. Heavy Duty Interior Strap      | 11. Gutter Fascia End Cap (Lefthand Shown) |
| 6. Liner End Cap (Lefthand Shown) |  |