

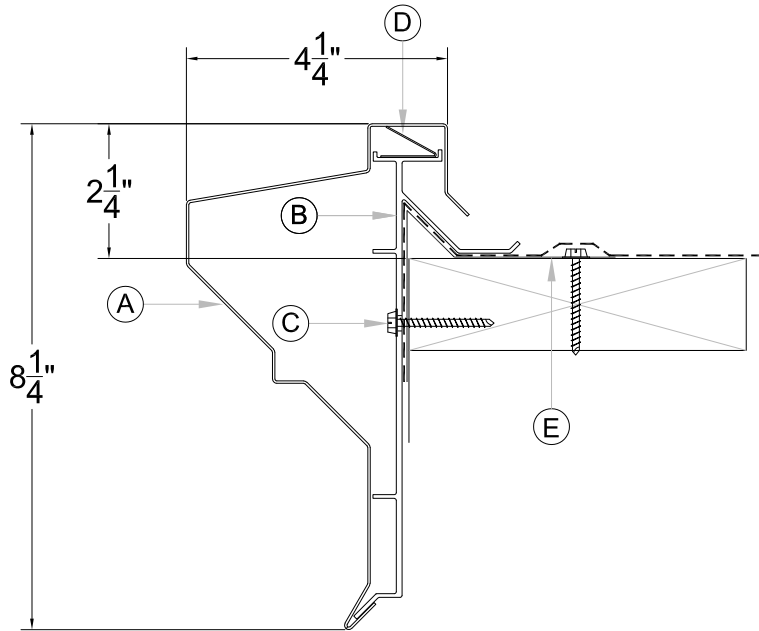

SUBMITTAL / DATA SHEET

Designer Series Press-Loc Gravel Stop
Geometric Collection
8" Model PLGS.GC3-8



Legend:

- A: Snap-on Decorative Fascia, 10' lengths. Joint treatment consists of a 3/8" expansion reveal and 4" wide concealed splice plate.
- B: Extruded Aluminum Secure Bar, 10' Length
- C: #12 x 1.5" S.S. Wood Screws @ 12" centers
- D: Stainless Steel Tension Clips @ 24" centers
- E: Metal Edging by Installer

Material Options

Metal	Coping
Aluminum	
0.040	<input type="checkbox"/>
0.050	<input type="checkbox"/>
0.063	<input type="checkbox"/>
0.080	<input type="checkbox"/>
0.090	<input type="checkbox"/>
0.125	
0.1875	
0.250	
Copper	
16 oz	<input type="checkbox"/>
20 oz	<input type="checkbox"/>
32 oz	<input type="checkbox"/>

Finish Options

Finish	Coping
EZ Mix Kynar	<input type="checkbox"/>
Custom Kynar	<input type="checkbox"/>
Anodized	<input type="checkbox"/>
Mill Finish	<input type="checkbox"/>

Similar to the Standard Press-Loc Gravel Stop
Model PLGS-8.0 tested to meet
ANSI/SPRI/FM 4435/ES-1 and RE-2
Standard Requirements

Designer Series Press-Loc Gravel Stop, Model PLGS.GC3-8: Press-Loc is designed to accommodate the rigid performance criteria of today's advanced roofing systems. It doesn't matter if your room membrane is E.P.D.M., Thermoplastic, Modified Bitumen, or a Built-up Roof, Press-Loc fits them all. Press-Loc allows you to install your metal edging to be flashed in accordance with your membrane manufacturer's specifications. The Secure Bar profile fully encapsulates your membrane ensuring a watertight and leakproof edge. Press-Loc's unique and simple design make installation fast and economical, while giving you a leak-proof gravel stop edge that is extremely resistant to wind uplift.

(Other Materials are Available upon Request)

*(Default Selections are **BOLD**)*

Customer:

Project:

Address:

Location:

Phone / Fax:

Architect: