

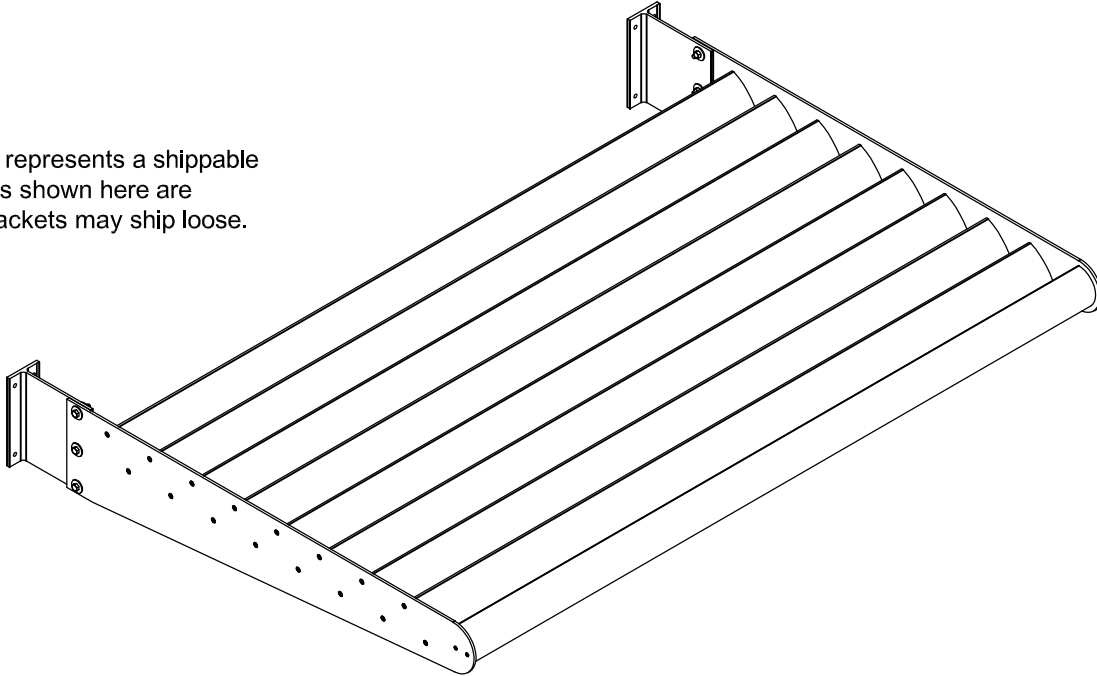

Metal Distribution, Finishing and Fabrication

**SAF Sun Control Systems
Air Foil Configuration**

This drawing represents a shippable unit; fasteners shown here are included. Brackets may ship loose.



SAF Sunshade: Options and Information

RFQ Documents	Architectural Drawings, Structural Drawing Sheet S1, and PE Calculations, if available
Engineered Substrate	Structural Engineering for structures/mounting surfaces is the responsibility of others and is beyond the scope of the undertaking of SAF
Finishes	Anodized or PVDF Painted Finishes
Engineering	All SAF Sunshades must be engineered by a professional Engineer prior to fabrication and installation. Installation not by SAF.
General size Limitations	Anodize Finish - 36" depth from building face x 78" wide. *see note below Painted Finish - 48" depth from building face x 75" wide. *see note below
Required Maintenance	Minimal: Clean with low pressure water and mild detergents
Price	Ranges with complexity of the project
Installation Rating	Moderate
	* = Max sizes determined by Engineer

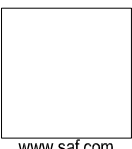
Customer:	Project:	 www.saf.com
Address:	Location:	
Phone / Fax:	Architect:	

Product Support:

SAF
1581 Huber Street, N.W.
Atlanta, GA 30318
Telephone 404-355-1560
Toll-free 800-241-7429
Fax 404-350-0581

SAF Metal Fabrication
14100 Veterans Memorial Hwy
Villa Rica, GA 30180
Telephone 770-942-1207
Toll-free 800-241-7429
Fax 770-942-4173

SAF Perimeter Systems Division
14100 Veterans Memorial Hwy
Villa Rica, GA 30180
Toll-free 800-334-9823
Fax 770-942-4173

SAF-West
4356 Caterpillar Road
Redding, California 96003
Telephone 530-244-7518
Toll-free 866-660-6627
Fax 530-244-7830

SAF-Midwest
5302 W. 78th Street
Indianapolis, IN 46268
Telephone 317-556-1890
Toll-free 800-357-9016
Fax 317-542-3031



Metal Distribution, Finishing and Fabrication

SAF Sun Control Systems Air Foil Configuration

Outriggers:

- Fully Customizable: $\frac{1}{4}$ " Aluminum Plate, in 6061-T6 for painted finish and 6063-T5 for anodized finish

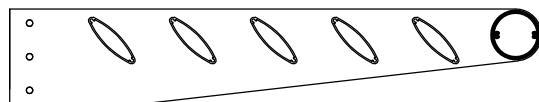
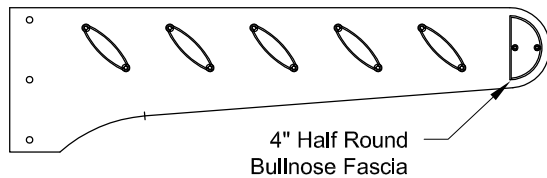
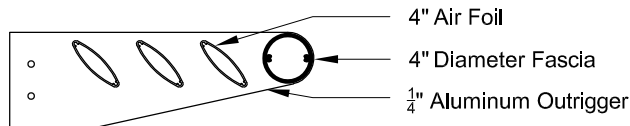

Brackets:

- Available in lengths up to 8" from mounting surface.
- 6061-T6 customizable aluminum extrusions.

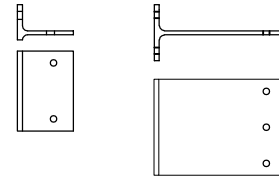

Air Foils:

- Available in 4", 6", and 8".

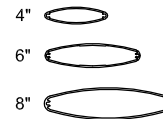

Materials:

- Air Foils & Fascia - 6063-T6 Aluminum Alloy
- Brackets - 6061-T6 Aluminum Alloy
- Outriggers - 6063-T5 and 6061-T6 Aluminum Alloy - Restrictions apply

Blade Configurations:

- Varies, based on desired amount of sun control and design
- Blade angles can be adjusted for different geographical locations

Material Thickness:

- Air Foils & Fascia - .080" - .110" Thick Walls
- Brackets - .375" Thick Cap & Stem
- Outriggers - .25" Aluminum Plate

System Configurations:

- Single Span
- Multiple Span

System Dimensions:

- Up to a 48" depth and a 78" width for a single span sunshade - all systems require PE Stamp

Options:

Product Support:

SAF
1581 Huber Street, N.W.
Atlanta, GA 30318
Telephone 404-355-1560
Toll-free 800-241-7429
Fax 404-350-0581

SAF Metal Fabrication
14100 Veterans Memorial Hwy
Villa Rica, GA 30180
Telephone 770-942-1207
Toll-free 800-241-7429
Fax 770-942-4173

SAF Perimeter Systems Division
14100 Veterans Memorial Hwy
Villa Rica, GA 30180
Toll-free 800-334-9823
Fax 770-942-4173

SAF-West
4356 Caterpillar Road
Redding, California 96003
Telephone 530-244-7518
Toll-free 866-660-6627
Fax 530-244-7830

SAF-Midwest
5302 W. 78th Street
Indianapolis, IN 46268
Telephone 317-556-1890
Toll-free 800-357-9016
Fax 317-542-3031